

## PRINTING AND FITTING SPECIFICATIONS

- Print this document on A4 sheets of paper (21 x 29.7cm).
- Ensure you print at 100 % scale.
- Measure both sides of this box to check scale is correct.
- Fit the prints together following the numbering system on the edge of each sheet. Ensure crosses are aligned.
- Tape the sheets together and cut around the Pack's outline
- When fitting this printed template to your bike, keep in mind that the Frame Pack will be more flexible as it is built from fabric.

10cm  
3.9in

10cm / 3.9in

## SCALE EXAMPLE OF FINAL TEMPLATE

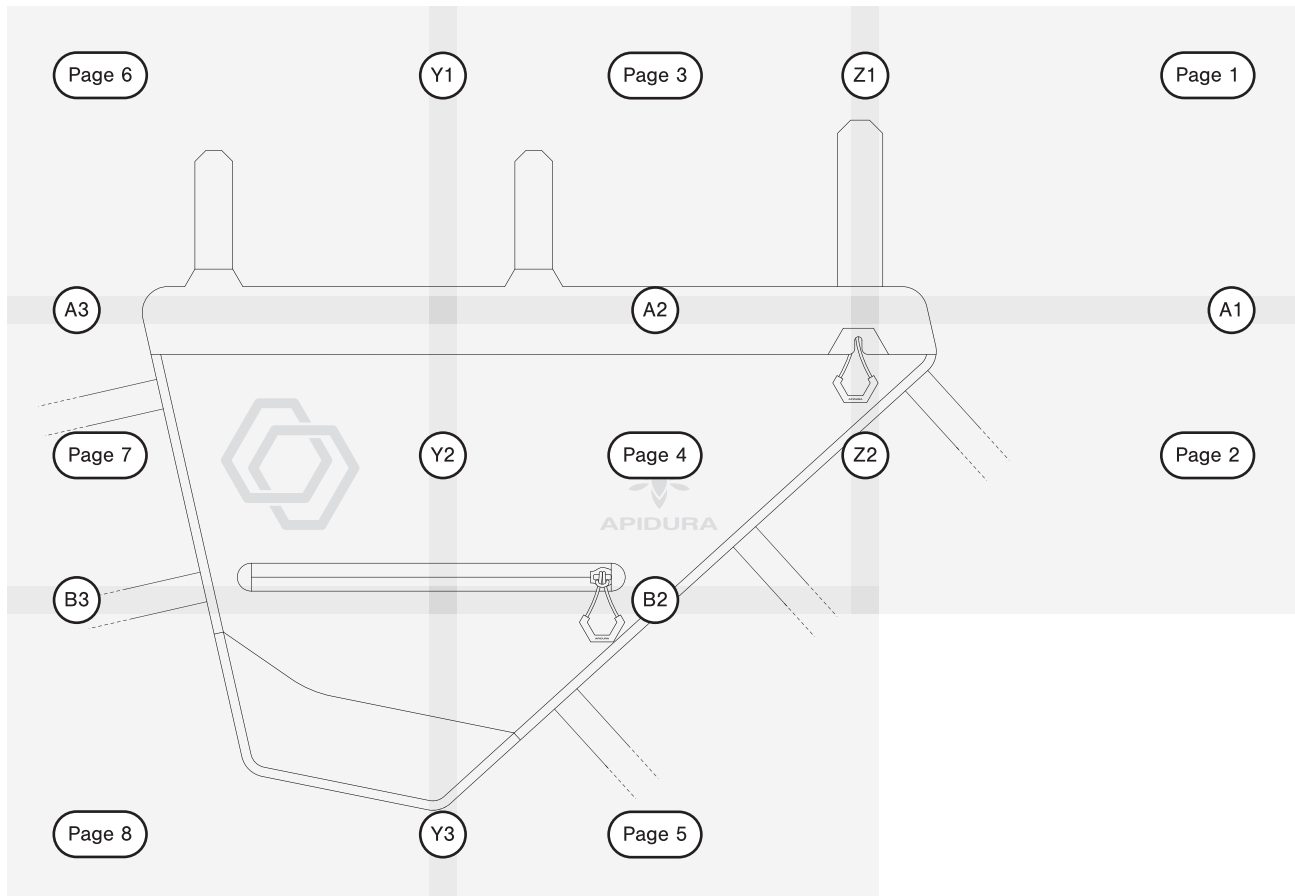

A1



X Z1



A1  
X

This webbing strap is  
26cm long (10.2in long)

X

X Z2

X

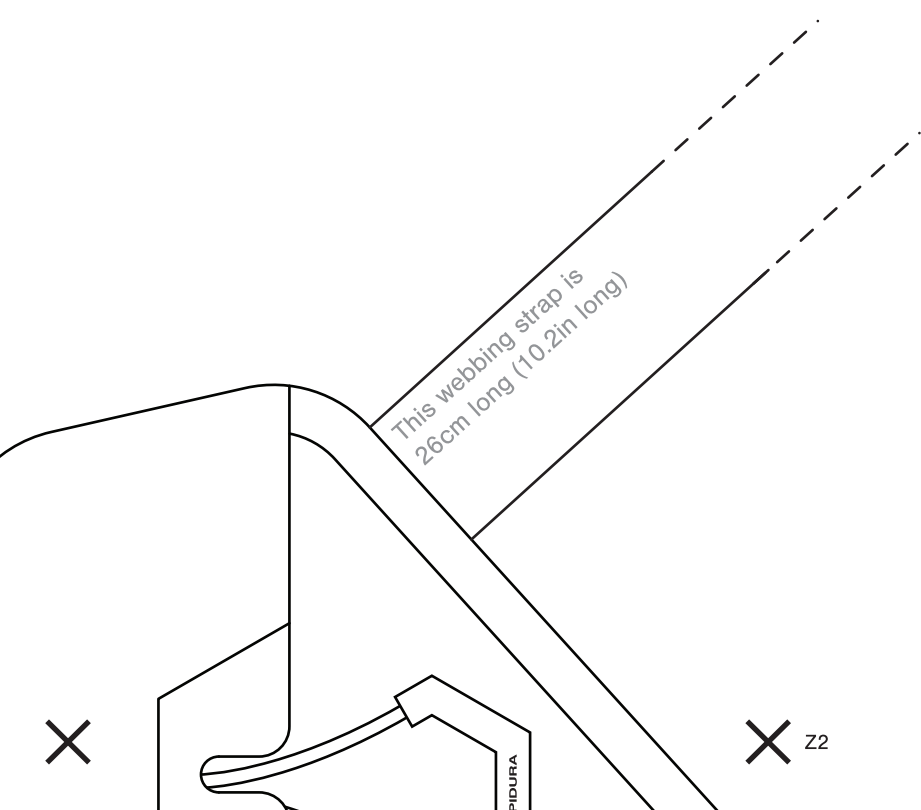

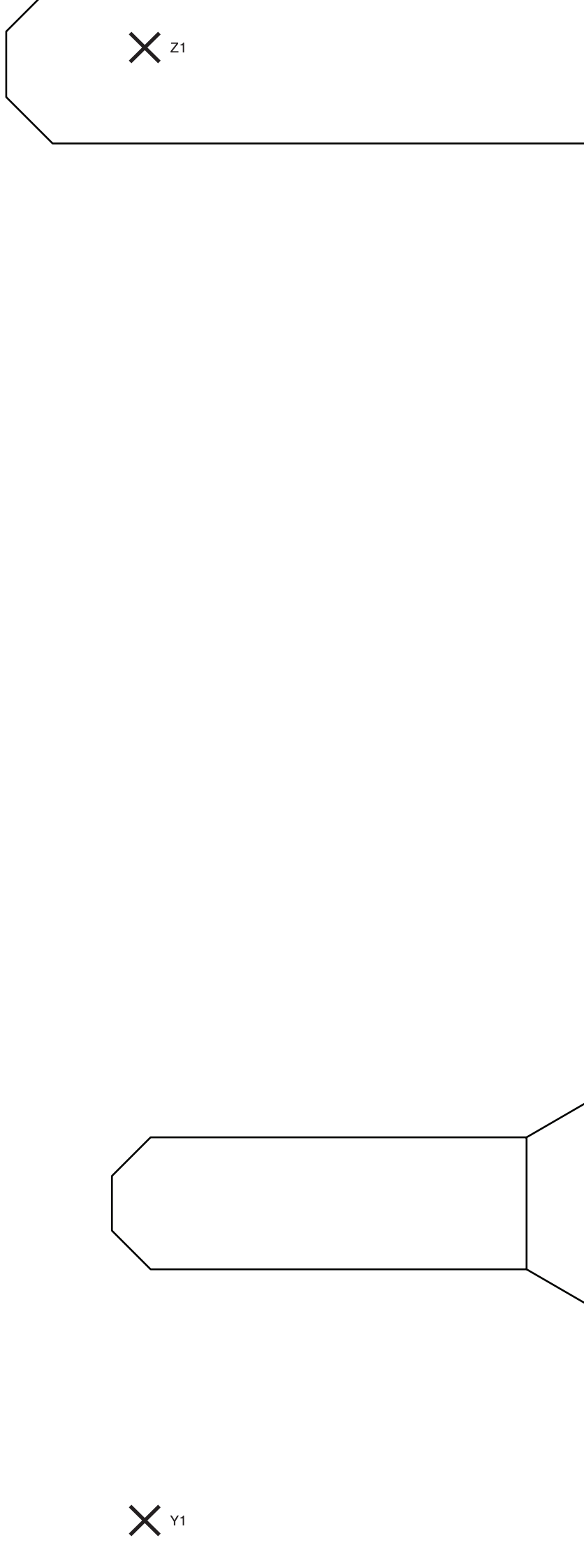

X Z1

X

A2  
X

X Y1

X

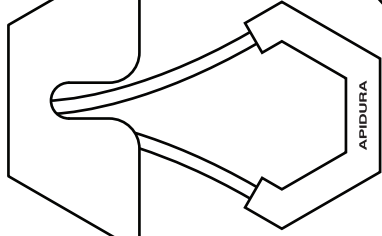

This webbing strap is  
26cm long (10.2in long)



APIDURA

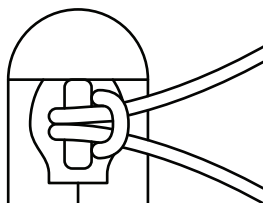

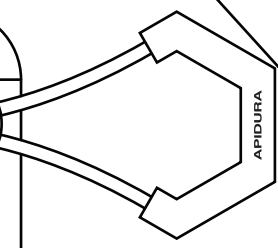
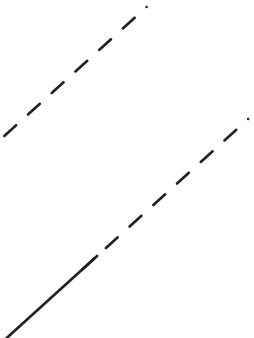

This webbing strap is  
26cm long (10.2in long)



X Y1

X

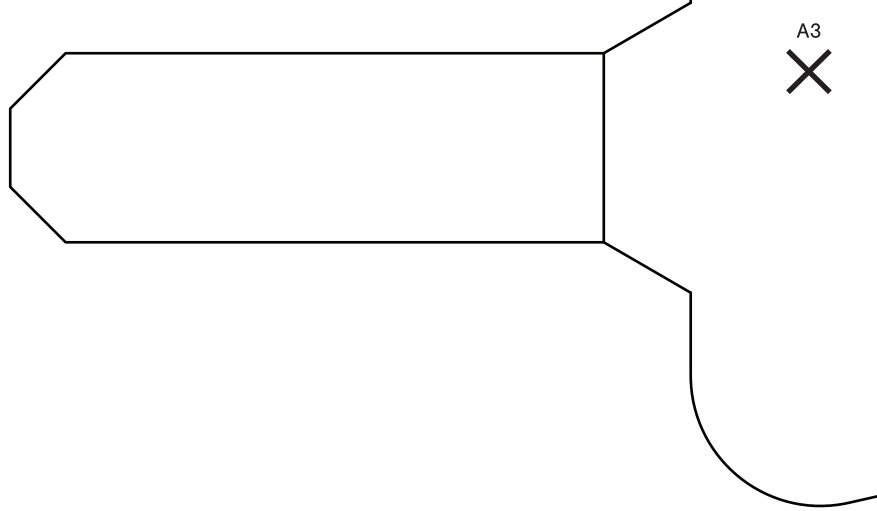

A3  
X



EXPEDITION FULL FRAME PACK (12L)

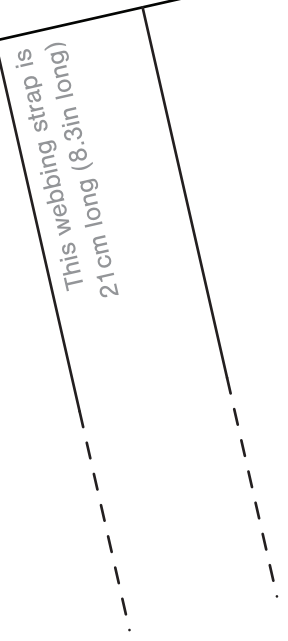
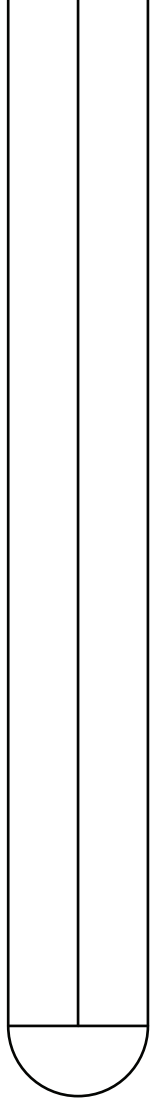

This webbing strap is  
21cm long (8.3in long)



This webbing strap is  
21cm long (8.3in long)

